

LeBra®

Owner's Manual

Model #55941 - LeBra® Dodge Caravan

About Your Global Accessories Product

Congratulations on your purchasing decision. Global Accessories, Inc. designed the LeBra® Front End Cover to be the very best available. With proper care, your LeBra® Front End Cover will provide years of stylish looks and maximum protection.

Installation of the LeBra® Front End Cover is a simple process that should take about 30 minutes. Removal and reinstallation (as for car washing) takes just a few minutes.

If you encounter any problems during the installation of your LeBra® Front End Cover, please contact our Consumer Response Department, Monday - Friday, 9AM - 4PM (MST) at 1-800-950-9502.

Note: Please read this manual thoroughly before beginning the installation. After completing installation, keep this manual for further reference.

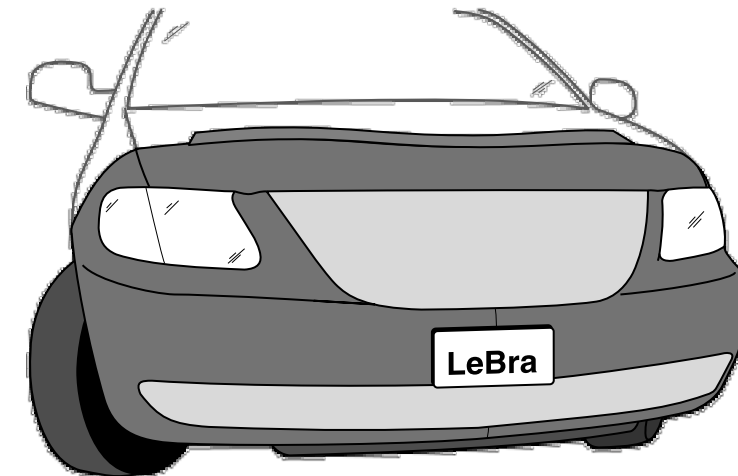

Tips for Easier Installation and Care

- [] Before Installation, wash and wax your vehicle. Use a paste wax—not a spray—on the hood and fenders in order to maintain the finish underneath the LeBra® Front End Cover.
- [] Install the LeBra® Front End Cover in temperatures of 70°F (21°C) or higher. The warmth will make the fabric more pliable and will allow it to stretch slightly for a tighter and smoother fit.
- [] Do not use vinyl cleaners or protectants on your LeBra® Front End Cover. These cleaners reduce the breathability of the vinyl and will void the Global Accessories Warranty.
- [] Do not install the LeBra® Front End Cover on any vehicle that does not still have its original factory paint. Global Accessories will not be held liable for any warranty claims of paint damage to repainted vehicles.
- [] Remember that the LeBra® Front End Cover also protects paint from fading due to sunlight while the rest of the car is exposed. Global Accessories will not be held liable for any warranty claims on sun-faded paint.
- [] **Caution:** There may be elastic straps described in some sections of this manual that can snap back if not properly hooked. To avoid injuries, exercise caution and use safety glasses when installing.
- [] Where available, always use the loops sewn to the cover to remove the plastic clips. **DO NOT PULL UP ON THE CLIPS OR THE FABRIC TO REMOVE THE COVER.** When removing the cover, it will be easiest to reverse the installation steps.

Contents	
Parts List	Pg. 2
Installation Instructions	
Hood Cover	Pg. 2
Front End Cover	Pg. 2

Unpacking: What You Have

Remove all parts from the shipping container. Check each part included against the following Parts List and look for any possible damage from shipping.

Parts List

Item	Description	Qty
1	Cover, hood	1
2	Cover, front end	1
3	Warranty	1
4	Care and Maintenance Pamphlet	1

The right side of the fabric is indicated as:



The Hood Cover

One of the features that makes your LeBra® Front End Cover the very best available is the separate Hood Cover. This means that you can access the engine compartment without removing or adjusting the cover. Install the Hood Cover first, by following these steps:

Step One

Open the hood and slip the Hood Cover over the front edge of the hood. Make sure that the corners of the hood fit snugly into the corners of the Hood Cover. When the Hood Cover fits snugly, stretch the fabric at straps to remove major wrinkles.

Step Two

Pull one of the straps sewn to the Hood Cover to the hole in the hood's underside as shown in Figure 1. Adjust the Buckle Hook so that it is about 1/2" away from the hole. Now pull the strap down and slip the Buckle Hook into the hole. To release the tension on the webbing for adjustment of the strap, simply pull out on the tab on the Buckle Hook (see Figure 2).

Figure 1

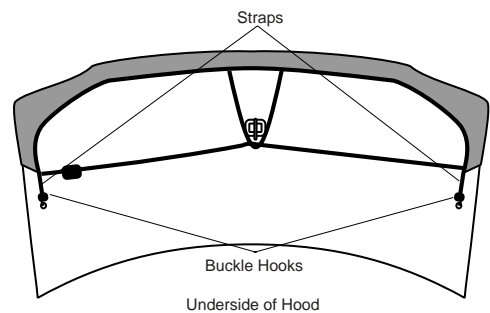

The Strap should be quite taut (as taut as possible without tearing). Relocate the Buckle Hook if necessary to tighten. Tie off excess strap to keep free of the engine compartment. Repeat this process for the other side.

Note: Check all straps periodically to insure tension. Adjust tightness if necessary.

Figure 2

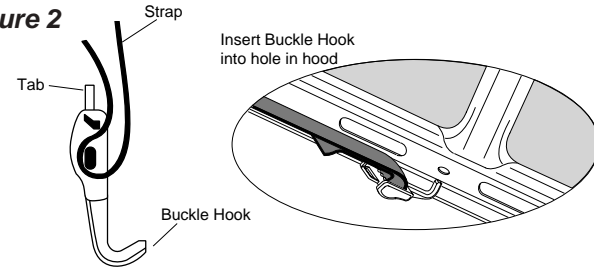

Step Three

With the Hood Cover in place, pull the fabric on the sides of the hood around to the underside of the hood on both sides. This will insure maximum tightness of the Hood Cover (see Figure 3).

Figure 3

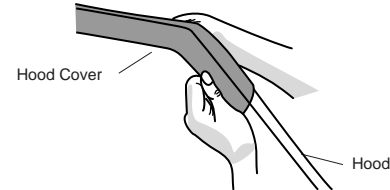

Step Four

The remaining strap provides better tension and stability for the cover. Stretch the remaining strap across the underside of the hood, through the loop sewn to the front of the cover and thread it through the buckle on the opposite side (see Figure 4a). Do not twist the strap. Pull the end of the strap straight in line with the buckle to remove slack. DO NOT OVERTIGHTEN. Loop the excess strap back through the buckle to keep it out of the engine compartment (see Figure 4b).

Figure 4

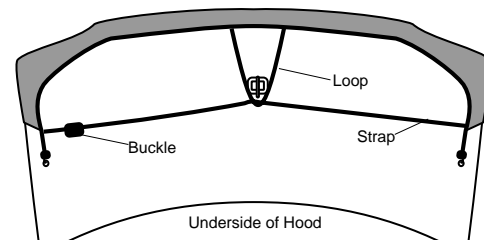
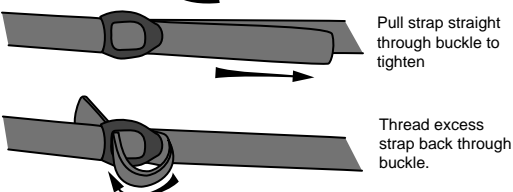

Figure 4a



Figure 4b



Installing the Front End Cover

This section explains how to install the front cover portion of your LeBra® Front End Cover.

Note: Instructions for license plate opening. Cut out the indented, rectangular area in the center of the cover, if you choose to use your front license plate. Be sure to cut inside and as close to the indentation as possible.

Step One

Orient the cover on the vehicle. The bottom of the cover will be stamped on the inside. If necessary slip the cover over the license plate bracket.

Note: Turn the wheels for easier access to the wheel wells.

Step Two

Pull the cover back to one of the wheel wells and locate the four plastic clips sewn to the cover in the wheel well (see Figure 5). Hook the clips to the edge of the fender. Pull the cover around the front of the vehicle and attach it to the other wheel well.

Figure 5

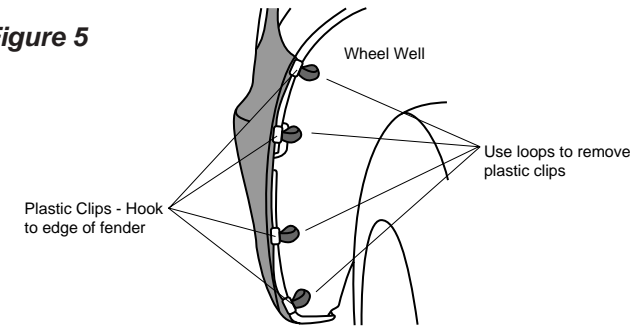

Step Three

Locate the reinforced pocket sewn to the cover below each headlight opening (see Figure 6). Slip the pocket under the headlight as far as possible.

Figure 6

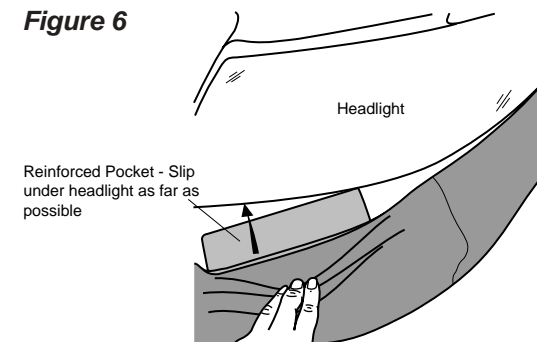

Step Four

Locate the plastic clips sewn to the top corners of the grille screen next to the headlights (see Figure 7). Hook the clips to the side of the grille.

Figure 7

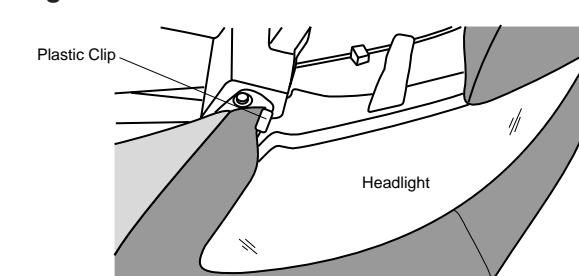

Step Five

Pull the screen up over the grille and locate the plastic clip sewn to the top of the screen. Hook the clip to the top edge of the grille (see Figure 8).

Figure 8

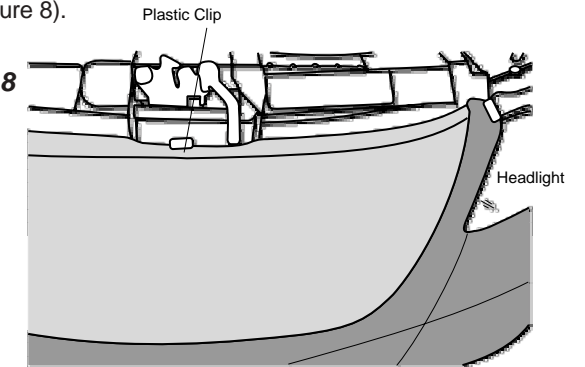

Step Six

Locate the five plastic clips sewn to the bottom of the cover, one under each fender and three across the front (see Figure 9). Hook the clips to the ledge under the vehicle.

Figure 9

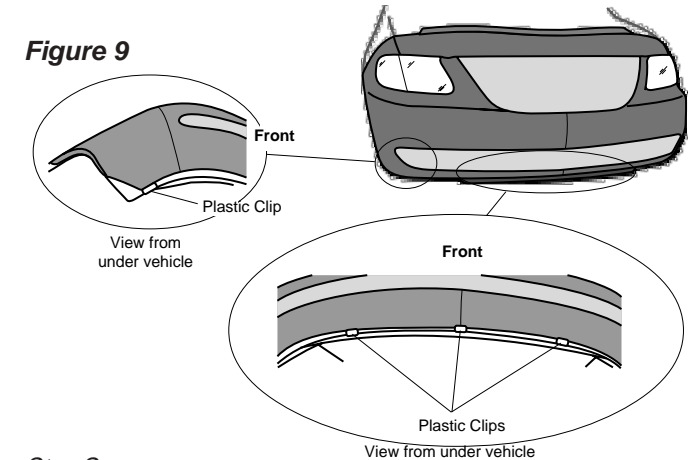

Step Seven

Pull the sides of the cover up over the fenders and slip the pocket sewn into the cover over the front corner of the fender above the headlight. Then locate the plastic clip sewn to the cover on each side of the engine compartment (see Figure 10). Hook the clips into the opening on each side of the vehicle.

Figure 10

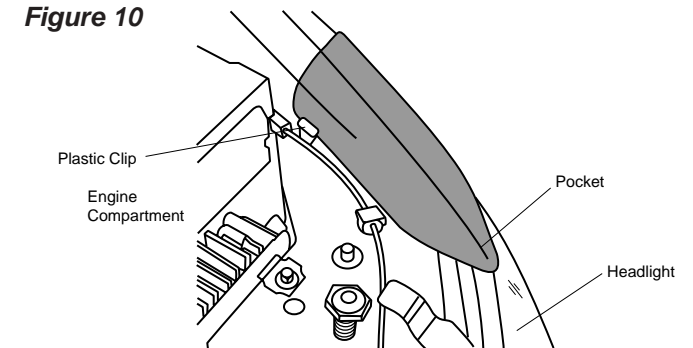

Note: Where available, always use the loops sewn to the cover to remove the plastic clips. DO NOT PULL UP ON THE CLIPS OR THE FABRIC TO REMOVE THE COVER. When removing the cover, it will be easiest to reverse the installation steps.

"This completes the installation of your custom-designed front end cover."